

Compact Living



REXA



Compact Living

design Monica Graffeo

REXA



An introduction

IT Eclettica, vivace. Esalta i piccoli spazi con geometrie innovative ed elementi multifunzionali per organizzare gli oggetti di uso quotidiano in modo semplice e pratico.

Moderna, sensoriale e materica, consente infinite configurazioni e abbinamenti.

Monica Graffeo: Compact Living è la collezione pensata per bagni di dimensioni ridotte con elementi dalle molteplici possibilità estetiche e funzionali.

Monica Graffeo: Compact Living ist die Kollektion, für kleine Bäder mit Elementen mit vielfältigen ästhetischen und funktionalen Möglichkeiten aufwertet.

DE Elektisch, lebendig. Er wertet kleine Räume mit multifunktionalen Elementen und innovativen Geometrien auf um Alltagsgegenstände auf einfache und praktische Weise organisieren.

Modern, sinnlich und materiell, ermöglicht er unendliche Konfigurationen und Kombinationen.

EN Eclectic, lively. It enhances small spaces with innovative geometries and multifunctional elements for organising everyday objects in a simple and practical way.

Modern, materic and sensory, allowing multiple layouts and combinations.

Monica Graffeo: Compact Living is the collection designed for small bathrooms with elements offering multiple aesthetic and functional possibilities.

Monica Graffeo: Compact Living es la colección pensada por los pequeños baños con elementos con múltiples posibilidades estéticas y funcionales.

ES Ecléctico, alegre. Realza los espacios pequeños con elementos multifuncionales y geometrías innovadoras para organizar los objetos cotidianos de forma sencilla y práctica.

Moderno, sensorial y matérico, permite infinitas configuraciones y combinaciones.

FR Éclectique, vivant. Elle met en valeur les petits espaces avec des géométries innovantes et des éléments multifonctionnels pour organiser les objets du quotidien de manière simple et pratique.

Moderne, matériel et sensoriel, permettant de multiples aménagements et combinaisons.

Monica Graffeo: Compact Living est la collection conçue pour les petites salles de bains avec des éléments offrant de multiples possibilités esthétiques et fonctionnelles.

An introduction

What is Compact Living

1.

Organizzazione funzionale

Lavabi attrezzati e accessori a corredo.

Functional organization

Equipped washbasins and related accessories.

Organisateur fonctionnel

Vasques équipées et accessoires associés.

Funktionelle Organisation

Ausgestattete Waschbecken und dazu passendes Zubehör.

Organización funcional

Lavabos equipados y accesorios suministrados.

3.

Materiali inediti

Versatilità espressa in lamiera metallica o Corian®.

New materials

Versatility expressed in sheet metal or Corian®.

Nouveaux matériaux

Polyvalence exprimée en Métal ou en Corian®.

Noch nie dagewesene Materialien

Vielseitigkeit, ausgedrückt in Metalelementen oder Corian®.

Materiales inéditos

Versatilidad expresada en chapa metálica o Corian®.

2.

Geometrie dinamiche

Molteplici larghezze e 3 profondità racchiuse in una struttura a 45 gradi.

Dynamic geometries

Multiple widths and 3 depths enclosed in a 45 degree-cut structure.

Géométries dynamiques

Plusieurs largeurs et 3 profondeurs enfermées dans une structure à 45 degrés.

Dynamische Geometrien

Mehrere Breitenmasse und 3 Tiefen eingebettet in einem 45 Grad geschnittenen Korpus.

Geometrías dinámicas

Múltiples anchuras y 3 profundidades encerradas en una estructura de 45 grados.

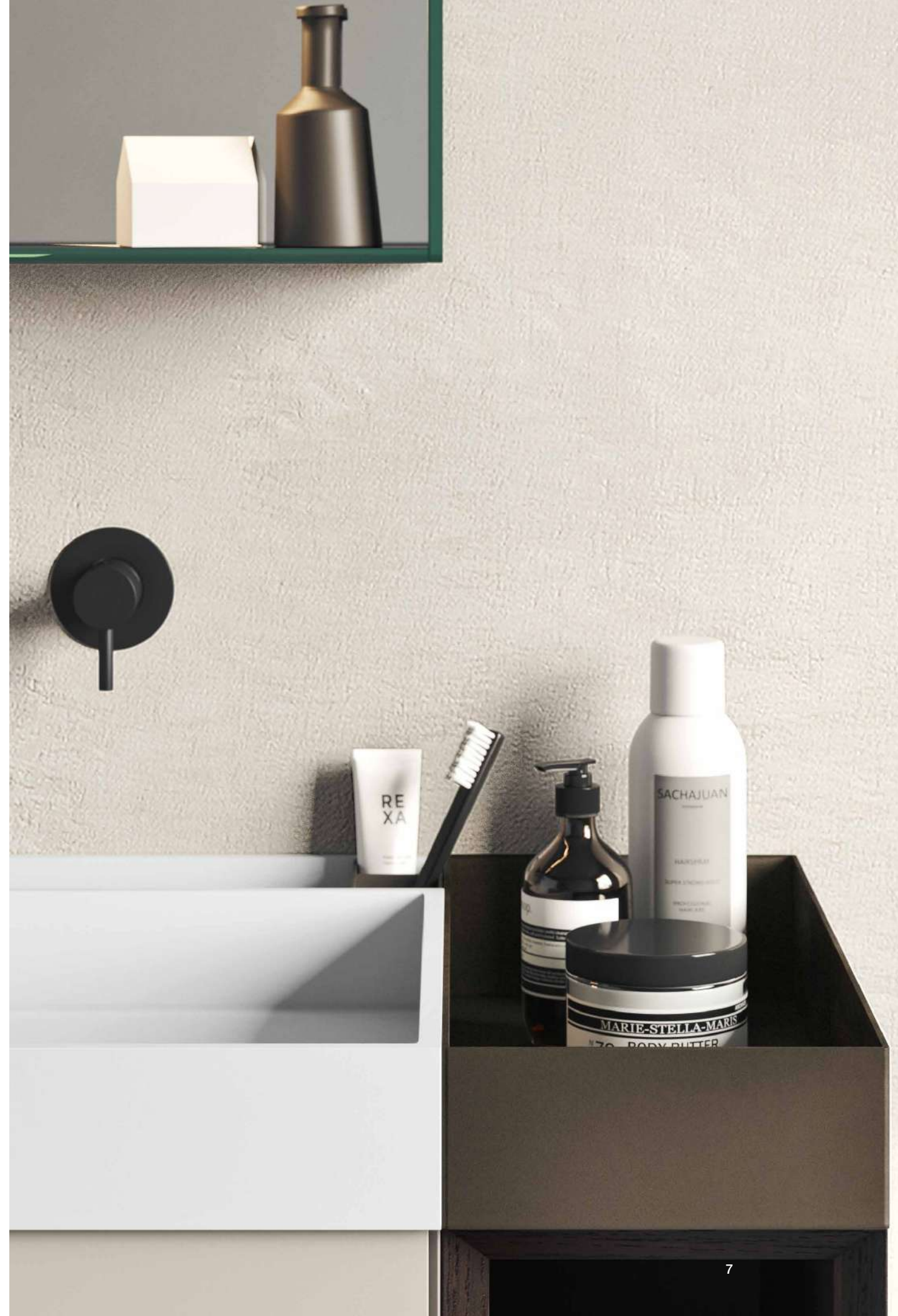

Compact Living Catalogue Contents

11 Collection

97 Elements

117 Materials, Colours

122 About Monica Graffeo

124 Inside Rexa

126 Collection Index

Collection

IT I piccoli spazi non sono un limite o il ripiego ad una necessità ma, come dei nidi, ci accolgono e coccolano nella loro preziosa intimità.

EN Small spaces are not a limit to the necessity but, like nests, they welcome us in their precious intimacy.

FR Les petits espaces ne se limitent pas à la nécessité mais, comme les nids, ils nous accueillent dans leur précieuse intimité.

DE Kleine Räume sind nicht auf die Notwendigkeit beschränkt, sondern empfangen uns wie Nester in ihrer kostbaren Intimität.

ES Los espacios pequeños no se limitan a la necesidad sino que, como los nidos, nos acogen en su preciosa intimidad.

Composition 1

IT Base 90x46x25h cm e base lavabo 60x46x25h cm, apertura push pull, in laccato opaco Grafite e base 60x46x25h cm in rovere Black. Lavabo *Eve* 60x46x8h cm in Corian® Carbon Concrete e vaschetta 30x46x8h cm in lamiera verniciata nera. Top appoggio 90x46x1,2 e 30x46x1,2h cm in Corian® Carbon Concrete. Miscelatore *Mae* per lavabo e doccia in acciaio Black Luxury. Specchiere *Pois* 59x10x40h cm e 30x10x20h cm in lamiera verniciata nera. Doppio pensile 25x22x120 h cm in rovere Black. Sgabello *Fonte* laccato nero opaco.

EN Cabinet 90x46x25h cm and 60x46x25h cm sink unit, push-pull opening, in matt lacquer Grafite and 60x46x25h cm cabinet in oak Black. *Eve* washbasin 60x46x8h cm in Corian® Carbon concrete and tray 30x46x8h cm in black lacquered metal. Countertop 90x46x1,2 and 30x46x1,2h cm in Corian® Carbon Concrete. *Mae* mixers for basin and shower in Black Luxury. *Pois* mirrors 59x10x40h cm and 30x10x20h cm in black lacquered metal. Double wall unit 25x22x120h cm in rovere Black. *Fonte* matt black lacquered stool.

FR Élément 90x46x25h cm et élément lavabo 60x46x25h cm, ouverture push pull, en laqué mat Grafite et élément 60x46x25h cm en chêne Black. Lavabo *Eve* 60x46x8h cm en métal laqué noir. Plan à poser 90x46x1,2 et 30x46x1,2h cm en Corian® Carbon Concrete. Mitigeurs *Mae* Black Luxury pour lavabo et douche. Miroir *Pois* 59x10x40h cm et 30x10x20h cm en métal laqué noir. Double meuble haut 25x22x120 h cm en chêne Black. Tabouret *Fonte* laqué noir mat.

DE Schubladenschrank 90x46x25h cm und Unterschrank 60x46x25h cm, Push-Pull-Öffnung, aus matt lackiertem Grafite und Schubladenschrank 60x46x25h cm aus Eiche Black. Waschbecken *Eve* 60x46x8h cm aus Corian® Carbon Concrete und Tablett 30x46x8h cm schwarz lackiertem Metall. Platte 90x46x1,2 und 30x46x1,2h cm aus Corian® Carbon Concrete. Armaturen *Mae* für Waschbecken und Dusche Black Luxury. *Pois*-Spiegel 59x10x40h cm und 30x10x20h cm aus schwarz lackiertem Metall. Doppelwandschrank 25x22x120h cm in Eiche Black. Mattschwarz lackierter Hocker *Fonte*.

ES Mueble con cajón de 90x46x25h cm y mueble para lavabo de 60x46x25h cm, apertura push-pull, en lacado mate Grafite y mueble con cajón de 60x46x25h cm en roble Black. Lavabo *Eve* 60x46x8h cm en Corian® Carbon Concrete y bandeja 30x46x8h cm en metal pintada de negro. Encimera 90x46x1,2 y 30x46x1,2h cm en Corian® Carbon Concrete. Mezclador *Mae* para lavabo y ducha Black Luxury. Espejos *Pois* 59x10x40h cm y 30x10x20h cm en metal pintado de negro. Mueble alto doble 25x22x120h cm en roble Black. *Fonte* taburete lacado negro mate.







Composition 2

- IT Base con cassetto, apertura push pull, 60x46x50h cm in laccato opaco Zenzero. Elemento a giorno in accosto 20x46x50h cm rovere Tobacco. Lavabo con organizer 60x46x8h cm in Korakril™ Blend e vaschetta separata in lamiera effetto materico 20x46x8h cm. Miscelatore nero opaco a parete della collezione *Drop*. Contenitore porta oggetti a parete 30x10x8h cm in lamiera effetto materico. Specchiera *Inside* 60x10x70h cm con cornice portaoggetti in vetro a specchio bifacciale e illuminazione integrata. Lampada *Nabila* tonda a sospensione in vetro con attacco nero.
- EN Cabinet with drawer, push pull opening system, 60x46x50h cm in matt lacquer Zenzero. Open element 20x46x50h cm in rovere Tobacco. Washbasin with organizer 60x46x8h cm in Korakril™ Blend and separate metal tray 20x46x8h cm raw effect. Black matt wall mixer from *Drop* collection. Metal wall holder raw effect 30x10x8h cm. *Inside* mirror 60x10x70h cm with storage frame made in double glass and integrated lighting. Suspended round *Nabila* lamp made in glass with black connection.
- FR Meuble tiroir en laqué mat Zenzero, système d'ouverture push pull, 60x46x50h cm. Élément ouvert 20x46x50h cm en chêne Tobacco. Lavabo avec organisateur 60x46x8h cm en Korakril™ Blend et bac en métal effet brut 20x46x8h cm. Mitigeur *Drop* mural en finition noire. Etagère mural en métal effet brut 30x10x8h cm. Miroir *Inside* 60x10x70h cm avec cadre de rangement en verre face et éclairage inclus. Lampe *Nabila* ronde suspendue en verre avec connexion en noir.
- DE Schubladenschrank aus matt lackierte Zenzero, mit Push-Pull Öffnungssystem, 60x46x50h cm. Öffenen Element 20x46x50h cm aus Eiche Tobacco. Waschbecken mit Veranstalter 60x46x8h cm aus Korakril™ Blend und Meetalroheffekt Tablett 20x46x8h cm. Armatur *Drop* Schwarz ausführung. Metallroheffekt Wandhalter Regal 30x10x8h cm. Spiegel *Inside* 60x10x70h cm mit Rahmen aus doppelseitigem Glas und integrierte Beleuchtung. Hängend Lampe *Nabila* Rund aus Glas mit Schwarz Verbindung.
- ES Mueble con cajón, lacado mate Zenzero apertura push pull, 60x46x50h cm. Elemento abierto 20x46x50h cm en roble Tobacco. Lavabo con organizador 60x46x8h cm en Korakril™ Blend y bandeja de metal efecto crudo 20x46x8h cm. Grifo *Drop* negro a pared. Estante a pared en metal efecto crudo 30x10x8h cm. Espejo *Inside* 60x10x70h cm con estructura realizada en vidrio de doble cara y iluminación integrada. Lámpara redonda suspendida *Nabila* en vidrio con conexión en negro.



You may also like

- IT Top 120x46x8h cm in Korakril™ Blend Ice White. Basi con cassetto 60x46x50h e 30x46x50h cm in laccato opaco Verde Pino. Vano a giorno 30x46x50h cm in rovere Tobacco.
- EN Top 120x46x8h cm in Korakril™ Blend Ice White. Cabinets with drawer 60x46x50h and 30x46x50h cm in matt lacquer Verde Pino. Open Element 30x46x50h cm in oak Tobacco.
- FR Plan 120x46x8h cm en Korakril™ Blend Ice White. Éléments avec tiroir 60x46x50h et 30x46x50h cm en laqué mat Verde Pino. Élément ouvert 30x46x50h cm en chêne Tobacco.
- DE Platte 120x46x8h cm in Korakril™ Blend Ice White, Unterscharank mit Schublade 60x46x50h und 30x46x50h cm in Mattlack Verde Pino. Offenes Element 30x46x50h cm in Eiche Tobacco.
- ES Encimera 120x46x8h cm en Korakril™ Blend Ice White. Muebles con cajón 60x46x50h y 30x46x50h cm en lacado mate Verde Pino. Elemento abierto 30x46x50h cm en roble Tobacco.





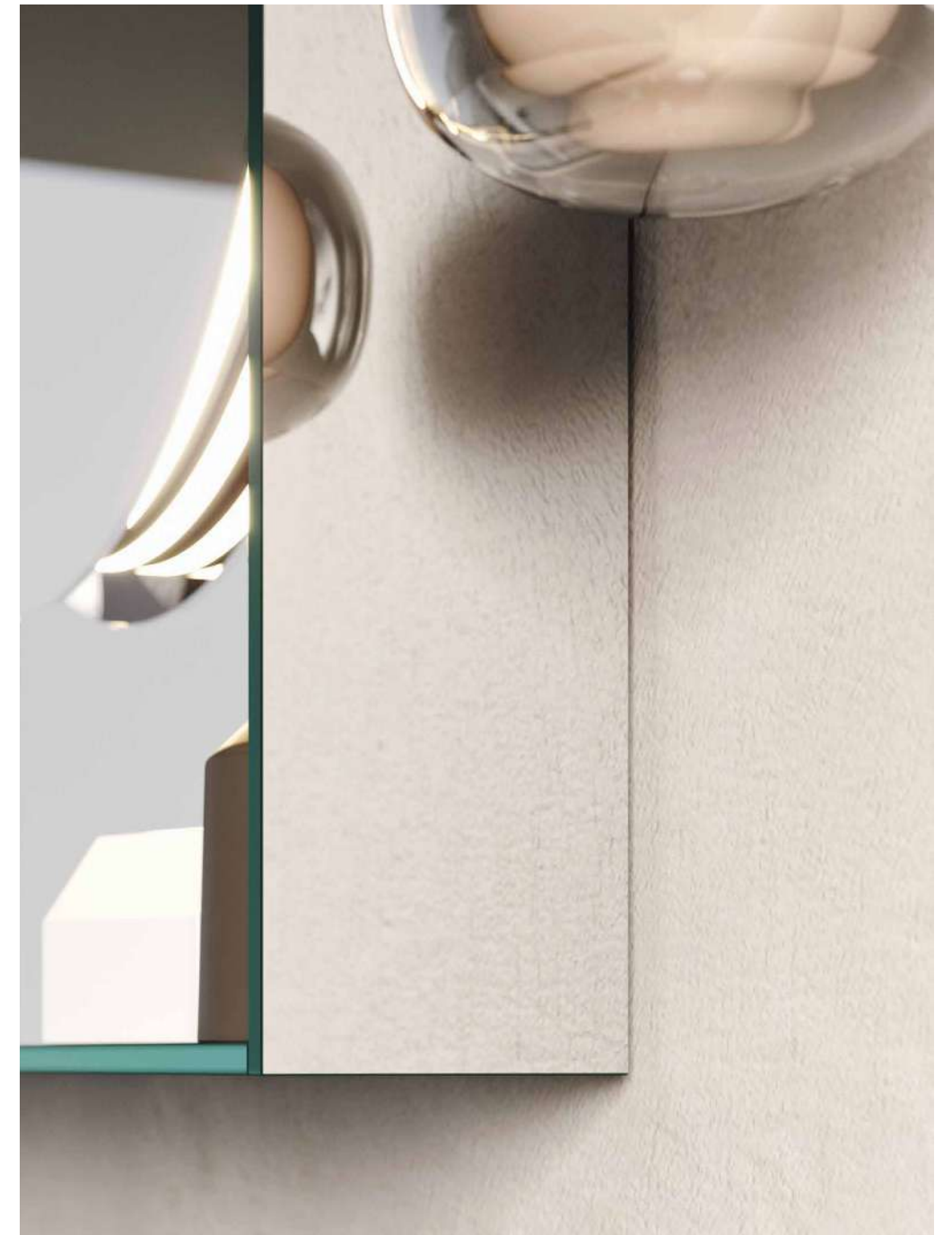



Focus

Accessori organizer
/Organizer accessories



Alloggio per rubinetteria/Mixer support

Focus

Accessori organizer
/Organizer accessories



Portaspazzolino + alloggio per rubinetteria + supporto per dispenser
/Toothbrush holder + mixer support + dispenser support



Supporto per dispenser e bicchiere + 2 portaspazzolini
/Dispenser and glass holder + 2 toothbrush supports

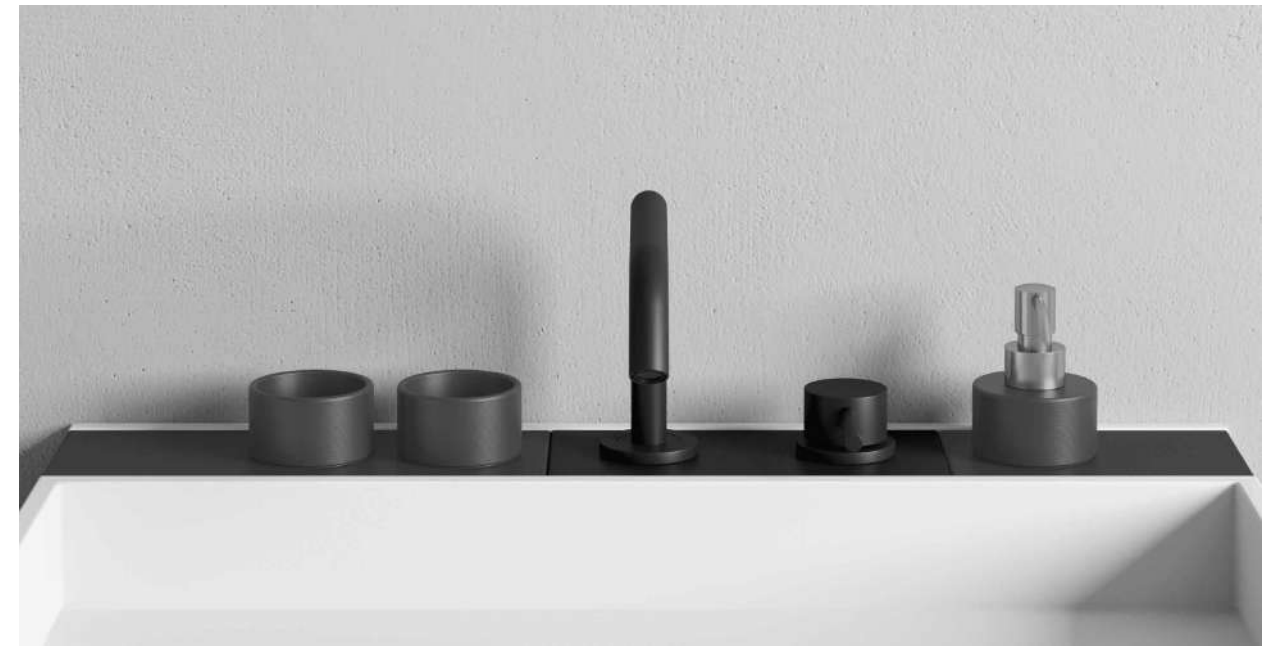

Supporto per bicchieri + alloggio per rubinetteria + supporto per dispenser
/Glass holder + mixer support + dispenser support



Composition 3

- IT Basi con cassetto, apertura con gola, 80x46x40h cm in rovere Tobacco. Elemento a giorno in accosto 20x46x40h cm in lamiera materica. Lavabo 80x46x8h cm in Corian® Ash Aggregate con doppia vaschetta 20x46x8h cm in Corian® Neutral Concrete e portasalviette in accosto nella stessa finitura Corian® 10x46x8h cm. Miscelatore a parete della collezione *Mae* in Black Luxury. Specchiera *Pin* 45x90h cm con cornice in rovere Tobacco. Lampada *Osman* a parete in finitura nero.
- EN Cabinet with drawer, grip recess opening system, 80x46x40h cm in Roak Tobacco with metal raw effect open element 20x46x40h cm. Washbasin in Corian® Ash Aggregate 80x46x8h cm with two Corian® Neutral Concrete trays 20x46x8h cm on both sides and one towel rail in the same Corian® finishing 10x46x8h cm on the left side. Black Luxury wall mixer from *Mae* collection. *Pin* mirror 45x90h cm with frame in oak Tobacco. Wall *Osman* lamp with black connection.
- FR Meuble tiroir en chêne Tobacco 80x46x40h cm, ouverture avec gorge et élément ouvert latéral en métal effet brut 20x46x40h cm. Lavabo 80x46x8h cm en Corian® Ash Aggregate avec double bac 20x46x8h cm en Corian® Neutral Concrete et porte-serviettes côté gauche dans la même finition Corian® 10x46x8h cm. Mitigeur *Mae* en Black Luxury. Miroir *Pin* 45x90h cm avec cadre en chêne Tobacco. Lampe *Osman* avec connexion en noir.
- DE Unterschrank aus Eiche Tobacco, Griff-öffnungssystem, 80x46x40h cm mit offene Metallelement mit Roheffekt 20x46x40h cm. Waschbecken aus Corian® Ash Aggregate 80x46x8h cm mit zwei Corian® Neutral Concrete Offenes Fach 20x46x8h cm und ein Handtuchhalter aus das gleiche Corian®-Ausführung 10x46x8h cm auf der linken Seite. Armatur *Mae* aus Black Luxury. *Pin*-Spiegel 45x90h cm mit Rahmen in Eiche Tobacco. Lampe an Wand *Osman* mit Schwarz Verbindung.
- ES Mueble con cajón en roble Tobacco, apertura con ranura, 80x46x40h cm con dos elementos abiertos en metal efecto crudo 20x46x40h cm. Lavabo en Corian® Ash Aggregate 80x46x8h cm con dos bandejas en Corian® Neutral Concrete 20x46x8h cm y un portatoallero en el mismo acabado 10x46x8h cm a la izquierda. Grifo *Mae* en Black Luxury. Espejo *Pin* 45x90h cm con marco en roble Tobacco. Lámpara *Osman* a pared con conexión negro.







Focus

Lavabi/Washbasins



Lavabo/Washbasin: Corian® Glacier White
Vaschette/Trays: Corian® Glacier White

Focus

Lavabi/Washbasins



Lavabo/Washbasin: Corian® Glacier White
Vaschette/Trays: Corian® Neutral Concrete



Lavabo/Washbasin: Corian® Dune Prima
Vaschette/Trays: Corian® Neutral Concrete



Lavabo/Washbasin: Corian® Carbon aggregate
Vaschette/Trays: Corian® Carbon Concrete

Composition 4

- IT Base vassoio, apertura pull, 60x46x40h cm in argilla Beige, con contenitori interno cassetto. Lavabo materico *Wall.E* sospeso in lamiera effetto materico 60x46x8h cm. Miscelatore a parete della collezione *Mae* in Black Luxury. Specchiera *Carré* 60x10x70h cm con cornice porta-oggetti in vetro a specchio bifacciale. Vasca *Mini* 120x80x55h cm in Corian® Glacier White. Gruppo miscelatore *Mae* per vasca e soffione a parete tondo in acciaio Black Luxury. Pensili *Compact Living* 40x22x120h cm in argilla Beige.
- EN Beige clay unit with tray, pull opening system, 60x46x40h cm. *Wall.E* suspended washbasin 60x46x8h cm in metal raw effect. Black Luxury mixer from *Mae* collection. *Carré* mirror 60x10x70h cm with storage frame made in double sided glass. *Mini* bathtub 120x80x55h cm made in Corian® Glacier White. Black Luxury wall mixer group *Mae* for bathtub and wall round shower head. Compact Living Beige clay wall units 40x22x120h cm.
- FR Meuble en argile beige avec top contenant, système d'ouverture à la main, 60x46x40h cm. Lavabo *Wall.E* suspendu en Métal effet brut 60x46x8h cm. Mitigeur *Mae* en acier Black Luxury. Miroir *Carré* 60x10x70h cm avec cadre de rangement en double face verre. Baignoire *Mini* 120x80x55h cm en Corian® Glacier White. Groupe de mitigeur mural *Mae* pour baignoire et pomme de douche ronde en Black Luxury. Éléments hauts *Compact Living* en argile Beige 40x22x120h cm.
- DE Schubladeschrank mit Tablett aus Lehm Beige, ziehen Öffnungssystem, 60x46x40h cm. Metallroheffekt aufgehängt *Wall.E* Waschbecken 60x46x8h cm. Armatur *Mae* aus Black Luxury. Spiegel *Carré* 60x10x70h cm mit mit Rahmen und Regal aus doppelseitigem Glas. *Mini* Badewanne 120x80x55h cm aus Corian® Glacier White. *Mae*-Mischerarmatur für Badewanne und Kopfbrause rund aus Black Luxury ausführung. *Compact Living* Hängeschränke aus Lehm Beige 40x22x120h cm.
- ES Mueble de arcilla beige y bandeja, sistema de apertura de tiro, 60x46x40h cm. Lavabo suspendido *Wall.E* en metal efecto crudo 60x46x8h cm. Grifo *Mae* en Black Luxury. Espejo *Carré* 60x10x70h cm con marco en doble cara de Cristal. Bañera *Mini* 120x80x55h cm en Corian® Glacier White. Grifo *Mae* para bañera y rociador en acero Black Luxury. Muebles a pared *Compact Living* en arcilla Beige 40x22x120h cm.





Focus

Cassetto/Drawer



Composition 5

- IT Base con cassetto, apertura push pull 60x46x40h cm in laccato opaco Rosa Polvere. Elemento a giorno in accosto 30x46x40h cm in rovere Tobacco. Lavabo 60x46x8h cm con organizer porta-oggetti in Corian® Dune Prima e vaschetta destra 30x46x8h cm in Corian® Neutral Concrete. Miscelatore nero opaco da piano della collezione *Drop*. Accessori per organizer in lamiera laccata opaca nera. Combinazione specchi *Pois* 59x40h cm e 30x20h cm con cornice porta-oggetti in lamiera laccata opaca nera. Lampada *Circle* a parete nera.
- EN Rosa Polvere matt lacquered unit with drawer, push pull opening system, 60x46x40h cm. Tobacco oak open element 30x46x40h cm. Washbasin with organizer 90x46x8h cm made in Corian® Dune Prima and tray 30x46x8h cm in Corian® Neutral Concrete on the right side. Matt black mixer from *Drop* collection. Organizer accessories in matt black lacquered metal. *Pois* mirrors 59x40h cm and 30x20h cm with black matt lacquered metal storage frame. Black wall *Circle* lamp.
- FR Meuble laqué mat Rosa Polvere avec tiroir, ouverture push pull, 60x46x40h cm. élément ouvert en chêne Tobacco 30x46x40h cm. Lavabo avec organisateur 90x46x8h cm en Corian® Dune Prima et bac 30x46x8h cm en Corian® Neutral Concrete sur le côté droit. Mitigeur *Drop* en finition noir mat. Accessoires organisateur en métal laqué noir mat. Miroirs *Pois* 59x40h cm et 30x20h cm avec cadre de rangement en métal laqué noir mat. Lampe murale noire *Circle*.
- DE Unterschrank, 60x46x40h cm lackierte mat Rosa Polvere push pull Öffnungssystem. Offenes Element aus Eiche Tobacco 30x46x40h cm. Waschbecken mit Veranstalter 90x46x8h cm aus Corian® Dune Prima und Tablett 30x46x8h cm aus Corian® Neutral Concrete an Rechts. Armatur *Drop* aus Schwarz matt Ausführung. Veranstalter-Zubehören aus Schwarz matt lackiertem Metall. Spiegel *Pois* 59x40h cm und 30x20h cm mit Schwarz matt lackiertem Metall Regal. Lampe *Circle* an Wand Schwarz
- ES Mueble con cajón lacado opaco rosa Polvere apertura push pull 60x46x40h cm. Elemento abierto en roble Tobacco 30x46x40h cm. Lavabo con organizador de 90x46x8h cm en Corian® Dune Prima y bandeja 30x46x8h cm en Corian® Neutral Concrete en el lado derecho. Grifo *Drop* negro mate. Accesorios para organizador en metal lacado negro mate. Espejos *Pois* 59x40h cm y 30x20h cm con marco en metal lacado negro mate. Lámpara *Circle* a pared negra.



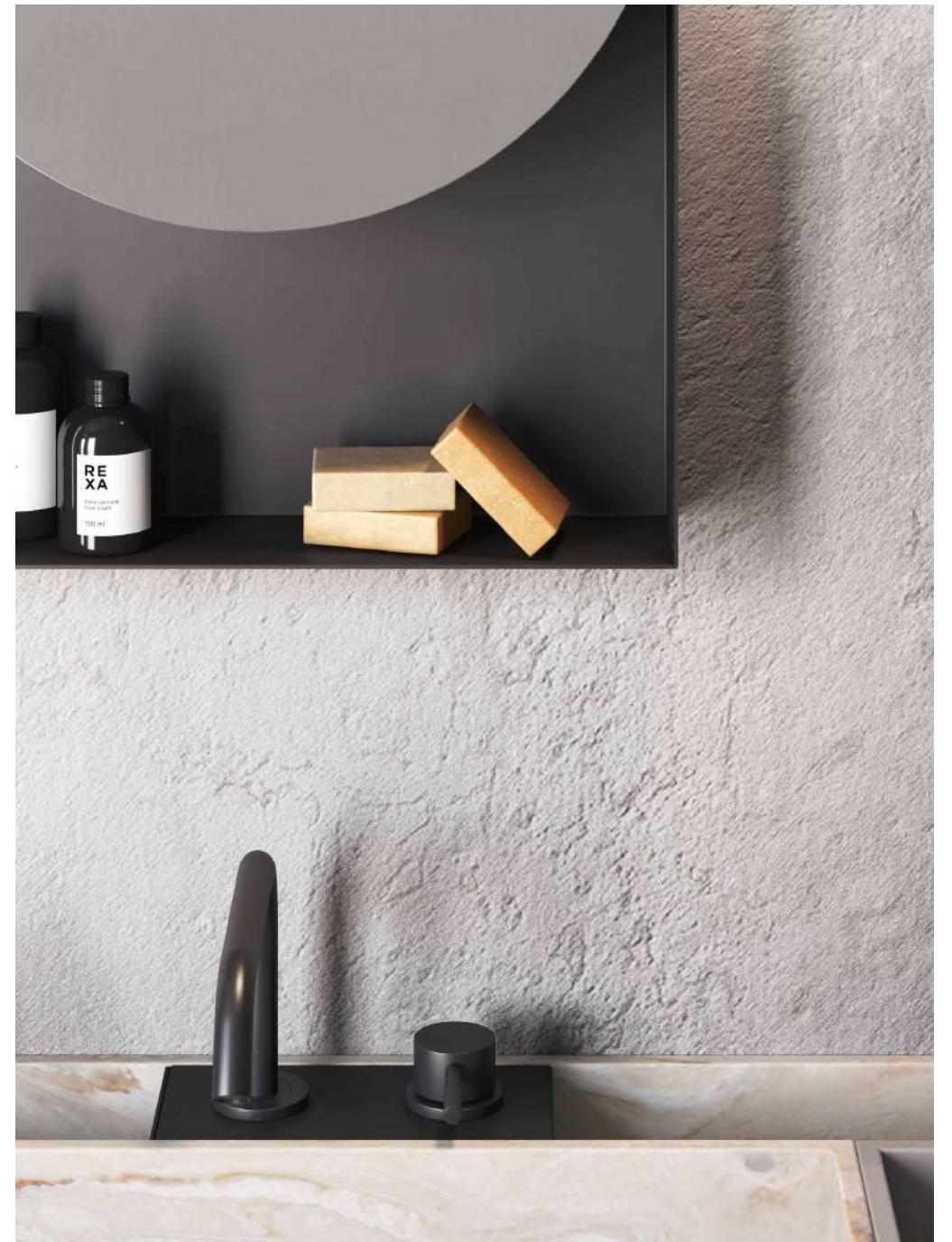

You may also like

- IT Base lavabo 60x46x50h cm e base con cassetto 40x46x50h cm in laccato opaco Beige Fresco. Lavabo con consolle trucco 100x46x8h cm in Corian® Glacier White.
- EN Sink unit 60x46x50h cm and cabinet with drawer 40x46x50h cm in matt lacquer Beige Fresco. Washbasin with make-up desk 100x46x8h cm in Corian® Glacier White
- FR Élément lavabo 60x46x50h cm et meuble tiroir 40x46x50h cm en laqué mat Beige Fresco. Lavabo avec console de maquillage 100x46x8h cm en Corian® Glacier White.
- DE Unterschrank 60x46x50h cm und Schubladenschrank 40x46x50h cm in Mattlack Beige Fresco. Waschbecken mit Make-up-Konsole 100x46x8h cm aus Corian® Glacier White
- ES Mueble para lavabo 60x46x50h cm y mueble con cajón 40x46x50h cm en lacado mate Beige Fresco Lavabo con consola de maquillaje 100x46x8h cm en Corian® Glacier White.



You may also like

- IT Base lavabo 100x46x40h cm in laccato opaco Verde Pino e base con cassetto 30x46x40h cm in rovere Tobacco. Lavabo con organizer e consolle trucco 100x46x8h cm in Corian® Glacier White e vaschetta 30x46x8h cm in lamiera nero opaco.
- EN Sink unit 100x46x40h cm in matt lacquer Verde Pino and cabinet with drawer 30x46x40h cm in oak Tobacco. Washbasin with organizer and make up desk 100x46x8h cm in Corian® Glacier White and tray 30x46x8h cm in black matt lacquered metal.
- FR Élément lavabo 100x46x40h cm en laqué mat Verde Pino et meuble tiroir 30x46x40h cm en chêne Tobacco. Lavabo avec organisateur et console de maquillage 100x46x8h cm en Corian® Glacier White et bac 30x46x8h cm en métal noir mat.
- DE Unterschrank 100x46x40h cm in matt lackiertem Verde Pino und Schubladenschrank 30x46x40h cm in Eiche Tobacco. Waschbecken mit Organizer und Make-up-Konsole 100x46x8h cm aus Corian® Glacier White und Tablett 30x46x8h cm aus schwarz matt lackiertem Metall.
- ES Mueble para lavabo 100x46x40h cm en lacado mate Verde Pino y mueble con cajón 30x46x40h cm en roble Tobacco. Lavabo con organizador y consola de maquillaje en Corian® Glacier White y bandejas 30x46x8h cm en metal negro mate.





Focus

Lavabi/Washbasins



Lavabo/Washbasin: Corian® Glacier White
Vaschetta/Tray: Corian® Glacier White

Focus

Lavabi/Washbasins



Lavabo/Washbasin: Corian® Ash aggregate
Vaschetta/Tray: Corian® Neutral Concrete



Lavabo/Washbasin: Corian® Glacier White
Vaschetta/Tray: Corian® Neutral Concrete



Lavabo/Washbasin: Corian® Carbon aggregate
Vaschetta/Tray: Corian® Carbon Concrete

Focus Make-up console

- IT Lavabo 60x46x8h cm con organizer porta-oggetti in Corian® Dune Prima e consolle trucco 40x46x8h cm in Corian® Neutral Concrete.
- EN Washbasin 60x46x8h cm with organiser in Corian® Dune Prima and make-up console 40x46x8h cm in Corian® Neutral Concrete.
- FR Vasque 60x46x8h cm avec organisateur de rangement en Corian® Dune Prima et console de maquillage 40x46x8h cm en Corian® Neutral Concrete.
- DE Waschtisch 60x46x8h cm mit Organizer aus Corian® Dune Prima und Make-up Konsole 40x46x8h cm aus Corian® Neutral Concrete.
- ES Lavabo 60x46x8h cm con organizador en Corian® Dune Prima y consola de maquillaje 40x46x8h cm en Corian® Neutral Concrete.



Composition 6

- IT Base con doppio cassetto, apertura con gola, 120x46x50h cm in laccato opaco Beige Fresco e lavabo *KB* in Korakril™ Blend 120x46x10h cm con doppio miscelatore della collezione *Drop* cromato. Portasalviette *Stone* 45x4h cm in Corian® Elegant Grey. Specchiera *Filolucido* 120x70h cm con mensola *Seamless* 120x9,2x10,5h cm in Corian® Glacier White. Lampada cilindrica *Osman* a sospensione in finitura nera.
- EN Beige Fresco matt lacquered unit with double drawer, grip recess opening system, 120x46x50h cm and *KB* Korakril™ washbasin 120x46x10h cm with chrome mixers from *Drop* collection. *Stone* towel rail 45x4h cm in Corian® Elegant Grey. *Filolucido* mirror 120x70h cm with *Seamless* shelf 120x9,2x10,5h cm in Corian® Glacier White. Suspended *Osman* lamp with black connection.
- FR Meuble laqué mat Beige Fresco avec double tiroir, système d'ouverture avec gorge, 120x46x50h cm et lavabo *KB* Korakril™ 120x46x10h cm avec mitigeurs chromé de la collection *Drop*. Porte-serviettes *Stone* 45x4h cm en Corian® Elegant Grey. Miroir *Filolucido* 120x70h cm avec étagère *Seamless* 120x9,2x10,5h cm en Corian® Glacier White. Lampe *Osman* suspendue avec connexion en noir.
- DE Schubladenschrank lackierte Beige Fresco matt mit zwei Schubladen mit Griff-öffnungssystem, 120x46x50h cm und Korakril™ Waschtisch *KB* 120x46x10h cm mit Waschtischmischer Chrom Ausführung vom *Drop*-Kollektion. *Stone* Handtuchhalter 45x4h cm aus Corian® Elegant Grey. *Filolucido* Spiegel 120x70h cm mit *Seamless* Ablage 120x9,2x10,5h cm aus Corian® Glacier White. Hängend Lampe *Osman* mit Schwarz Verbindung.
- ES Mueble lacado mate Beige Fresco con doble cajón, sistema de apertura con ranura, 120x46x50h cm y lavabo *KB* Korakril™ 120x46x10h cm con grifos cromados de la colección *Drop*. Porta-toallero *Stone* 45x4h cm en Corian® Elegant Grey. Espejo *Filolucido* 120x70h cm con estante *Seamless* 120x9,2x10,5h cm en Corian® Glacier White. Lámpara *Osman* suspendida con conexión negro.







IT In Compact Living il Corian® si esprime con una nuova identità, tracciando una matericità più espressiva.

EN Compact Living presents Corian® with a new identity focused more on an expressive material effect.

FR Compact Living présente Corian® avec une nouvelle identité, davantage axée sur un effet matériel plus expressif.

DE Compact Living präsentiert Corian® in einer neuen Identität, die sich auf die ausdrucksstarken Wirkungen der Materie konzentriert.

ES Compact Living introduce Corian® con una nueva identidad centrada más en un efecto material expresivo.

Composition 7

- IT Base con cassetto, apertura con gola, 100x46x50h cm in laccato Grigio pietra e vano a giorno in acciaio 20x46x50h cm in lamiera nero opaco. Top in Shark 120x46x1,2h cm con lavabo *Savon* 50x30h cm. Miscelatore della collezione *Mae* acciaio spazzolato. Specchiera *Halo* Ø70 cm con cornice in Corian® Deep Nocturne e illuminazione integrata. Lampada *Circle* a parete nera. Portasalviette *Stone* 45x4h cm e mensola in Corian® Deep Nocturne con bicchiere e porta spazzolino nero opaco.
- EN Grigio pietra matt lacquered unit with drawer, grip recess opening system, 100x46x50h cm and black matt lacquered metal open elements 20x46x50h cm on the right side. Matt Shark top 120x46x1,2h with *Savon* integrated washbasin 50x30h cm. Brushed stainless steel mixer from *Mae* collection. *Halo* mirror Ø70 cm with frame in Corian® Deep Nocturne and integrated led lighting. Black wall *Circle* lamp. *Stone* towel rail 45x4h cm and shelf with glass and soap dispenser holder made in Corian® Deep Nocturne.
- FR Meuble laqué Grigio pietra mat avec tiroir, système d'ouverture avec gorge, 100x46x50h cm et et élément ouvert en métal laqué noir mat 20x46x50h cm. Plan en Shark blanc mat 120x46x1,2h avec lavabo intégré *Savon* 50x30h cm. Mitigeur *Mae* en acier brossé. Miroir *Halo* Ø70 cm avec cadre en Corian® Deep Nocturne et éclairage led intégré. Lampe *Circle* noire. Accessoire porte-serviettes 45x4h cm et étagère avec verre et doseur savon en Corian Deep Nocturne.
- DE Grigio pietra matt lackierte Unterschrank, Griff-öffnungssystem, 100x46x50h cm und Schwarz matt offene Element aus lackierte Metall 20x46x50h cm. Waschtisch aus Matt Shark 120x46x1,2h mit *Savon* integriertem Becken 50x30h cm. *Mae* gebürsteter Edelmischer. *Halo* Spiegel Ø70 cm mit Rahmen aus Corian® Deep Nocturne und integrierter LED-Beleuchtung. *Circle* Schwarze Lampe an Wand. Handtuchhalter 45x4h cm und Regal mit Dispenser und Becher aus Corian® Deep Nocturne.
- ES Mueble lacado en Grigio pietra mate con cajón, sistema de apertura con ranura, 100x46x50h cm y elemento abierto de metal lacado negro mate 20x46x50h cm en el lado derecho. Encimera en Shark 120x46x1,2h con lavabo integrado *Savon* de 50x30h cm. Grifo *Mae* en acero cepillado. Espejo *Halo* Ø70 cm con marco en Corian® Deep Nocturne y iluminación led integrada. Lámpara *Circle* a pared negra. Porta-toallero 45x4h cm y estante con vaso y porta dispensador en Corian® Deep Nocturne.









You may also like

- IT Base lavabo, apertura push pull, 80x46x40h cm in laccato opaco Grafite e doppio vano a giorno 20x46x40h cm in lamiera nera opaca. Top 120x46x1,2h cm in Shark Grafite con lavabo integrato *Savon*.
- EN Sink unit, push-pull opening system, 80x46x40h cm in matt lacquered Grafite and double open element 20x46x40h cm in black matt lacquered metal. Top 120x46x1,2h cm in Shark Grafite with integrated basin *Savon*.
- FR Élément lavabo, ouverture push pull, 80x46x40h cm en laqué mat Grafite et double élément ouvert 20x46x40h cm en métal noir mat. Plan 120x46x1,2h cm en Shark Grafite avec vasque intégrée *Savon*.
- DE Unterschrank, Push-Pull-Öffnungssystem, 80x46x40h cm aus matt lackiertem Grafite und doppeltes offenes Element 20x46x40h cm aus schwarz matt lackiertem Metall. Platte 120x46x1,2h cm in Shark Grafite mit integriertem Waschbecken *Savon*.
- ES Mueble para lavabo, apertura push-pull, 80x46x40h cm en Shark Grafite lacado mate y doble elemento abierto 20x46x40h cm en metal negro mate. Encimera 120x46x1,2h cm en Shark Grafite con lavabo *Savon* integrado.



You may also like

- IT Base lavabo 100x46x25h cm e base con cassetto 40x46x25h cm, apertura push pull, in laccato opaco Grigio Luce. Top 100x46x1,2h cm in Shark Grigio Luce con lavabo integrato *Savon*.
- EN Sink unit 100x46x25 cm and cabinet with drawer 40x46x25cm, push-pull opening system in matt lacquered Grigio Luce. Top 100x46x1,2h cm in Shark Grigio Luce with integrated basin *Savon*.
- FR Élément lavabo 100x46x25h cm et meuble tiroir 40x46x25h cm, ouverture push pull, en laqué mat Grigio Luce. Plan 100x46x1,2h cm en Shark Grigio Luce avec vasque intégrée *Savon*.
- DE Unterschrank 100x46x25h cm und Schubladenschrank 40x46x25h cm, Push-pull Öffnungssystem in matt lackiertem Grigio Luce. Platte 100x46x1,2h cm in Shark Grigio Luce mit integriertem Waschbecken *Savon*.
- ES Mueble para lavabo 100x46x25h cm y mueble con cajón 40x46x25h cm, apertura push-pull, en Grigio Luce lacado mate. Encimera 100x46x1,2h cm en Shark Grigio Luce con lavabo *Savon* integrado.



You may also like

- IT Base lavabo, apertura push pull, 60x46x50h cm e vano a giorno 30x46x50h cm in laccato opaco Zenzero. Top 90x46x1,2h cm in Shark Zenzero con lavabo integrato Savon.
- EN Sink unit, push-pull opening system, 60x46x50h cm and open element 30x46x50h cm in matt lacquered Zenzero. Top 90x46x1,2h cm in Shark Zenzero with integrated basin Savon.
- FR Élément lavabo, ouverture push pull, 60x46x50h cm et élément ouvert 30x46x50h cm en laqué mat Zenzero. Plan 90x46x1,2h cm en Shark Zenzero avec vasque intégrée Savon.
- DE Unterschrank, Push-Pull-Öffnungssystem, 60x46x50h cm und offenes Element 30x46x50h cm in Zenzero, matt lackiert. Platte 90x46x1,2h cm in Shark Zenzero mit integriertem Waschbecken Savon.
- ES Mueble para lavabo, apertura push-pull, 60x46x50h cm y elemento abierto 30x46x50h cm en Shark Zenzero lacado mate. Encimera 90x46x1,2h cm en Shark Zenzero con lavabo Savon integrado.



You may also like

- IT Base lavabo, apertura push pull, 60x46x40h cm in Laccato opaco Fango Luce e doppio vano a giorno 30x46x40h cm in rovere Tobacco. Top 120x46x1,2h cm in Shark Fango Luce con lavabo integrato Savon.
- EN Sink unit, push-pull opening system, 60x46x40h cm in matt lacquered Fango Luce and double open element 30x46x40h cm in oak Tobacco. Top 120x46x1,2h cm in Shark Fango Luce with integrated basin Savon.
- FR Élément lavabo, ouverture push pull, 60x46x40h cm en laqué mat Fango Luce et double élément ouvert 30x46x40h cm en chêne Tobacco. Plan 120x46x1,2h cm en Shark Fango Luce avec vasque intégrée Savon.
- DE Unterschrank, Push-Pull-Öffnungssystem, 60x46x40h cm in Fango Luce matt lackiert und doppeltes offenes Element 30x46x40h cm in Eiche Tobacco. Platte 120x46x1,2h cm in Shark Fango Luce mit integriertem Waschbecken Savon.
- ES Mueble para lavabo, apertura push-pull, 60x46x40h cm en Shark Fango Luce lacado mate y doble elemento abierto 30x46x40h cm en roble Tobacco. Encimera 120x46x1,2h cm en Shark Fango Luce con lavabo Savon integrado.





Composition 8

- IT Basi lavabo, apertura con gola, 120x46x40h cm in rovere.
Top 240x46x1,2h cm in marmo Nero Marquinia e doppio lavabo in appoggio O_O Ø50 cm in Corian® Deep Nocturne. Doppia specchiera *Esperanto* girevole da piano con appendici con cornice in Corian® Deep Nocturne. Miscelatori *Drop* in nero opaco. Lampade *Bool* a sospensione e sgabello *Fonte* in frassino tinto olmo.
- EN Sink units with grip recess opening system, 120x46x40h cm in oak. Top 240x46x1,2h cm in marble Nero Marquinia and double over-counter basin O_O Ø50 cm in Corian® Deep Nocturne. Double *Esperanto* turning mirror on top with hooks in Corian® Deep Nocturne. Mixers *Drop* in matt black. *Bool* suspended lamps and *Fonte* stool in ash painted elm.
- FR Éléments lavabos, ouverture avec gorge, 120x46x40h cm en chêne. Plan 240x46x1,2h cm en marbre Nero Marquinia et double vasque à poser O_O Ø50 cm en Corian® Deep Nocturne. Double miroir *Esperanto* tournant sur plan avec crochets et cadre en Corian® Deep Nocturne. Mitigeurs *Drop* en noir mat. Lampe *Bool* suspendues et tabouret *Fonte* en frêne teinté orme.
- DE Unterschrank mit Griffmuldenöffnungssystem, 120x46x40h cm in Eiche. Platte 240x46x1,2h cm aus Marmor Nero Marquinia und Doppelwaschbecken O_O Ø50 cm aus Corian® Deep Nocturne. Doppelter drehbarer Spiegel *Esperanto* für die Installation auf der Platte mit Haken aus Corian® Deep Nocturne. Armatur *Drop* in mattschwarz. Hängelampen *Bool* und Hocker *Fonte* aus Esche, Ulme lackiert.
- ES Mueble para lavabo, sistema de apertura con ranura, 120x46x40h cm en roble. Encimera de 240x46x1,2h cm en mármol Nero Marquinia y lavabo doble sobre encimera O_O Ø50 cm en Corian® Deep Nocturne. Espejos *Esperanto* giratorio con colgadores con marco en Corian® Deep Nocturne. Mezcladores *Drop* en negro mate. Lámparas colgantes *Bool* y taburete *Fonte* en fresno teñido de olmo.





Focus

Lavabi/Washbasins



Top: Fenix® Nero Ingo
Lavabo/Washbasin: Marmo/Marble Nero Marquinia

Focus

Lavabi/Washbasins



Top: Corian® Glacier White
Lavabo/Washbasin: Corian® Dune Prima



Top: Corian® Glacier White
Lavabo/Washbasin: Marmo/Marble Carrara



Top: Corian® Carbon Concrete
Lavabo/Washbasin: Corian® Deep Nocturne

Composition 9

- IT Base con cassetto, apertura con gola, 80x53x50h cm e base in accosto con doppio cassetto 40x53x50h cm in argilla Grafite. Lavabo in Korakril™ Stone Sabbia 120x53x8h cm con organizer e pianetto laterale. Miscelatore della collezione *Mae* in Black Luxury. Specchiera *Reflex* 120x5x72,5h cm con vetro a specchio Bronzo. Contenitore porta oggetti 30x10x8h cm in lamiera laccata opaca nera.
- EN Sink unit with grip recess opening system, 80x53x50h cm and cabinet with double drawers 40x53x50h cm in clay Grafite. Washbasin in Korakril™ Stone Sabbia 120x53x8h cm with organizer and lateral top. Mixer from the *Mae* collection in Black Luxury. *Reflex* mirror 120x5x72,5h cm with mirrored glass Bronzo. Wall holder shelf 30x10x8h cm in black matt lacquer metal.
- FR Meuble tiroir, ouverture avec gorge, 80x53x50h cm et meuble double tiroir 40x53x50h cm en argile Grafite. Lavabo en Korakril™ Stone Sabbia 120x53x8h cm avec organisateur et plan latéral. Mitigeur de la collection *Mae* en Black Luxury. Miroir *Reflex* 120x5x72,5h cm avec verre à miroir Bronzo. Étagère murale 30x10x8h cm en métal laqué mat noir.
- DE Unterschrank mit Griffmuldenöffnung, 80x53x50h cm und Schubladenschrank 40x53x50h cm aus Lehm Grafite. Waschbecken aus Korakril™ Stone Sabbia 120x53x8h cm mit Organizer und seitlicher Platte. Armatur aus der Kollektion *Mae* in Black Luxury. Spiegel *Reflex* 120x5x72,5h cm mit verspiegeltem Glas Bronzo. Wandhalterung Regal 30x10x8h cm in schwarz matt lackiertem Metall.
- ES Mueble con cajón, apertura con ranura, 80x53x50h cm y mueble con doble cajón 40x53x50h cm en arcilla Grafite. Lavabo en Korakril™ Stone Sabbia 120x53x8h cm con organizador y encimera lateral. Mezclador de la colección *Mae* en Black Luxury. Espejo *Reflex* 120x5x72,5h cm con cristal de espejo Bronzo. Contenedor de almacenamiento de 30x10x8h cm de chapa lacada en negro mate.







Focus Colonne/Wall cabinets

- IT Combinazione di colonne in laccato opaco Beige Fresco 25x36x180h cm, vani a giorno con schienale in Corian® Ash Aggregate.
- EN Combination of columns in matt lacquered Beige Fresco 25x36x180h cm, open elements with back visible side in Corian® Ash Aggregate.
- FR Combinaison de colonnes en laqué mat Beige Fresco 25x36x180h cm, éléments ouvertes avec dos visible en Corian® Ash Aggregate.
- DE Hangeschränken Kombination aus Beige Fresco matt lackiert 25x36x180h cm, offenen Elementen mit Corian® Ash Aggregate Rückseite.
- ES Combinación de muebles colgantes lacados mate Beige Fresco 25x36x180h cm y elementos abierto con panel de atrás visible en Corian® Ash Aggregate.



Elements

IT Lo spirito della collezione è l'organizzazione: lavabi con organizer attrezzati e configurabili e accessori per gestire la routine quotidiana.

EN The soul of the collection is about organization: washbasins, configurable with organizers and accessories, to support the daily routine.

FR L'esprit de la collection est l'organisation : vasques avec organisateurs équipés et configurables et accessoires pour gérer la routine quotidienne.

DE Der Spirit dieser Kollektion ist die Organisation: Waschbecken, ausgestattet mit einem Aufbewahrungssystem, das die täglichen Alltagsbedürfnisse unterstützen.

ES El espíritu de la colección es la organización: lavabos con organizadores equipados y configurables y accesorios para gestionar la rutina diaria.

Enjoy the small spaces

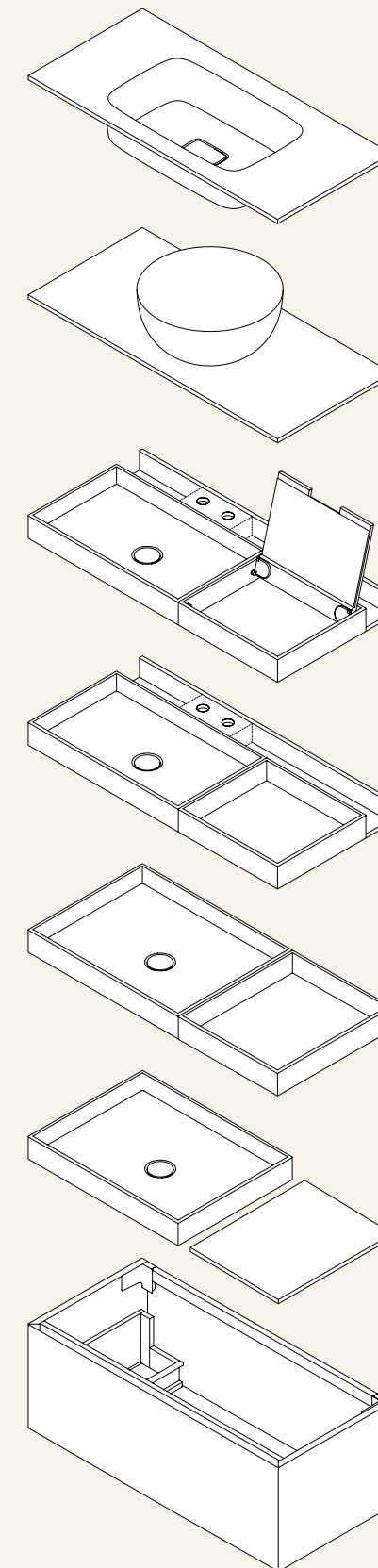



Componibilità/Modularity

Base lavabo + Vano a giorno o base
/Sink unit + Open element or unit
H 25-40-50 cm

Lavabi Compact Living
/Compact Living basins
P 46

Base lavabo/Sink unit
P 36-46-53

Vano a giorno/Open element
P 46-53

Base/Unit
P 36-46-53

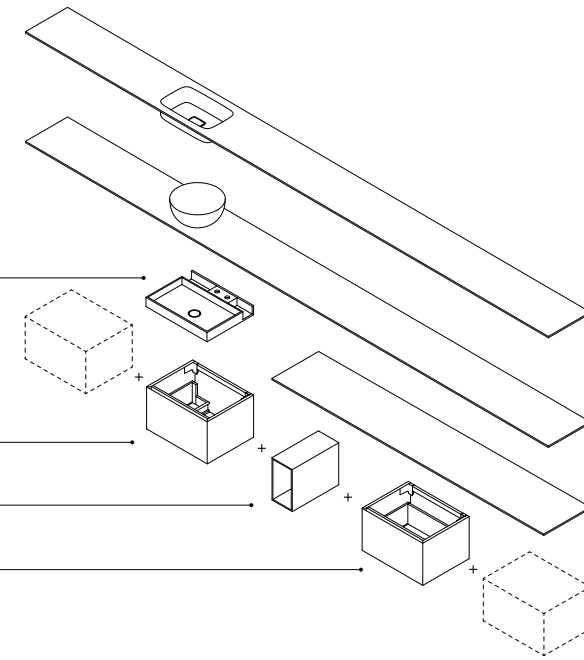

Top con lavabo integrato
/Top with integrated washbasin
P 46-53

Top con lavabo in appoggio
/Top for over counter washbasin
P 36-46-53

Top di finitura/Finishing top
P 36-46-53

Base vassoio + Vano a giorno
/Sink unit + Open element or unit
H 36 cm

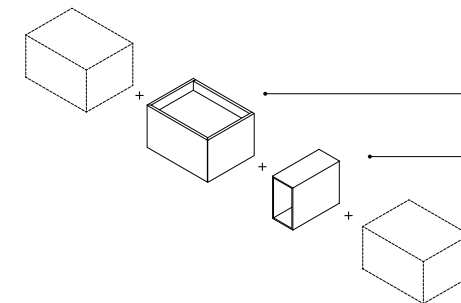

Base vassoio/Unit with tray
P 46

Vano a giorno/Open element
P 46

Pensile + pensile o colonna + colonna
/Wall elements + Wall elements or
Wall cabinets + Wall cabinets

Pensili/Wall elements
H 70-80-120 cm

Colonne/Wall cabinets
H 180-210 cm

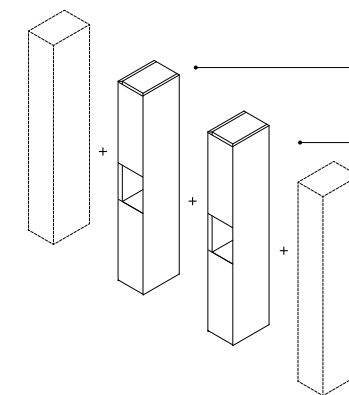

Pensile/Wall unit
P 22

Colonna/Wall cabinet
P 36



Aperture/Opening systems



Pull



Gola/Grip recess



Push-pull



Dettaglio apertura cassetto/Opening detail



Lavabi/Washbasins

Tipologia/Type

Materiali e colori
/Materials and colours

Wall.E
Appoggio, sospeso
/Over counter, wall-hung

Lamiera
/Metal
+2

L 60 P 46 H 8 cm

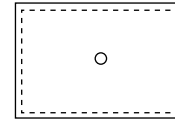

Eve
Appoggio/Over counter

Corian®
+12

L 60-70-80 P 46 H 8-12 cm

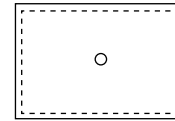

Angolo interno raggiato
/Internal rounded corners

Optional
Vaschette lamiera
abbinabili H 8 cm
/Trays available
in metal H 8 cm
→ p.112

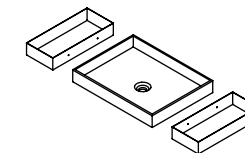

Lamiera
/Metal
+2

Lavabi/Washbasins

Tipologia/Type

Materiali e colori
/Materials and colours

KB
Appoggio, sospeso
/Over counter, wall-hung

**Korakril™
Blend
Ice White**

L 60-70-80-90-100-120 P 46 H 10 cm

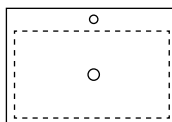

Lavabo/Basin
Appoggio, sospeso
/Over counter, wall-hung

**Corian®
+12**

L 60-70-80 P 46 H 8-12 cm

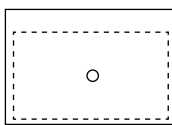

Sx + Dx
L 70-80-90-100-120 P 46 H 8-12 cm

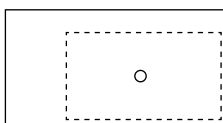

Optional
Vaschette lamiera
abbinabili H 8 cm
/Trays available
in metal H 8 cm
→ p.112

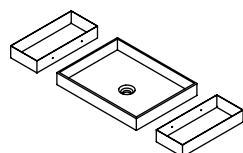

**Lamiera
/Metal
+2**

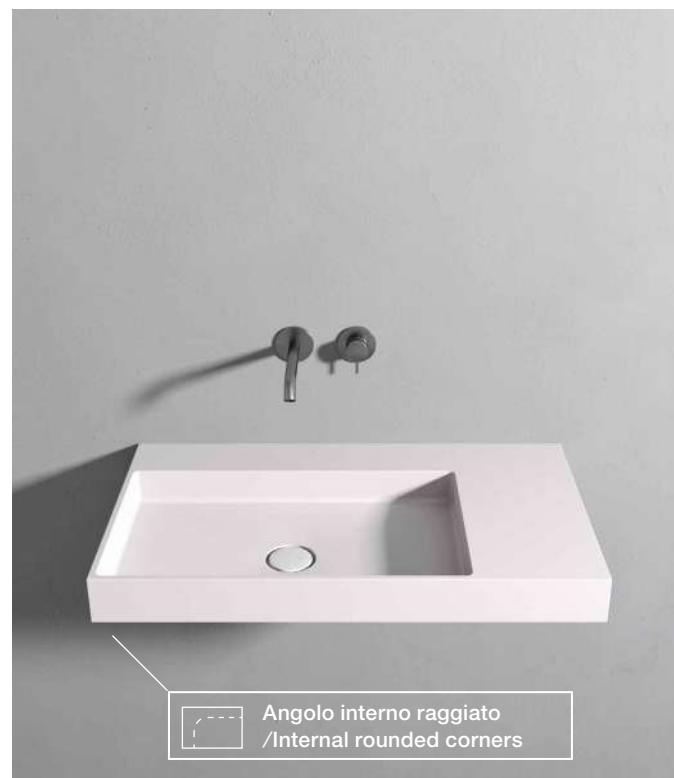

Lavabi/Washbasins

Tipologia/Type

Materiali e colori
/Materials and colours

Lavabo con organizer/Basin with organizer
Appoggio/Over counter

**Korakril™
+5**

L 60-70-80 P 46 H 8 cm

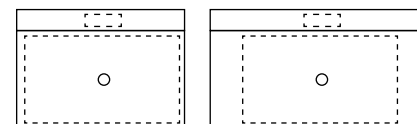

Sx + Dx
L 70-80-90-100-120-140 P 46 H 8 cm

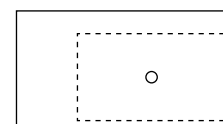

Optional
Portarubinetto
/Mixer support

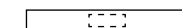

Vaschette lamiera
abbinabili H 8 cm
/Trays available
in metal H 8 cm
→ p.112

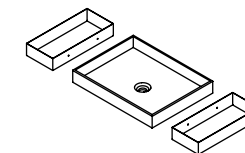

**Lamiera
/Metal
+2**



Lavabo con organizer/Basin with organizer
Appoggio/Over counter

**Corian®
+12**

L 60-70-80 P 46 H 8-12 cm

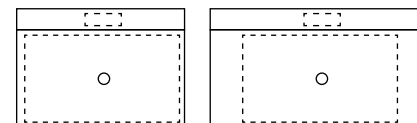

Sx + Dx
L 70-80-90-100-120-140 P 46 H 8-12 cm

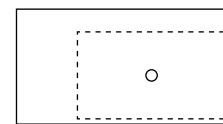

Optional
Portarubinetto
/Mixer support

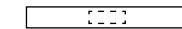

Vaschette lamiera
abbinabili H 8 cm
/Trays available
in metal H 8 cm
→ p.112

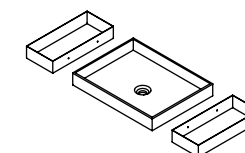

**Lamiera
/Metal
+2**



Lavabi/Washbasins

Tipologia/Type

Materiali e colori
/Materials and colours

Lavabo con vaschette
/Basin with trays
Appoggio/Over counter



L 100-120 P 46 H 8-12 cm

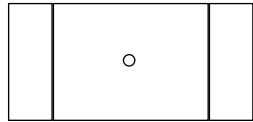

Sx + Dx
L 80-90-100-120 P 46 H 8-12 cm

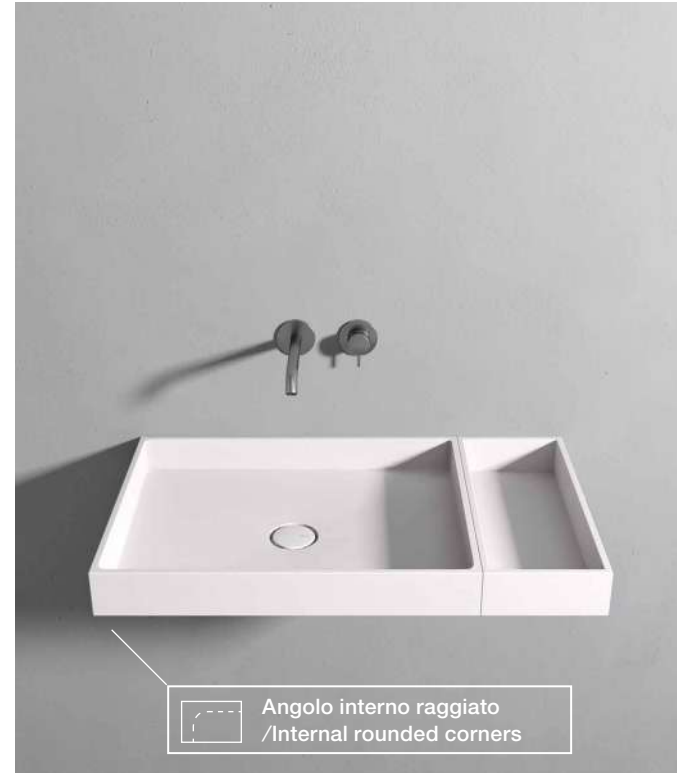
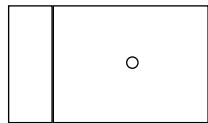

Lavabo con consolle trucco
/Basin with make-up console
Appoggio/Over counter



Sx + Dx
L 100-120 P 46 H 8 cm

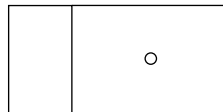

Lavabi/Washbasins

Tipologia/Type

Materiali e colori
/Materials and colours

Lavabo con vaschette e organizer
/Basin with trays and organizer
Appoggio/Over counter



L 100-120 P 46 H 8-12 cm

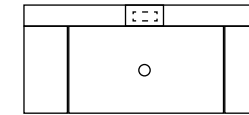

Sx + Dx
L 80-90-100 P 46 H 8-12 cm

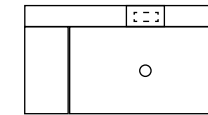

Optional
Portarubinetto
/Mixer support

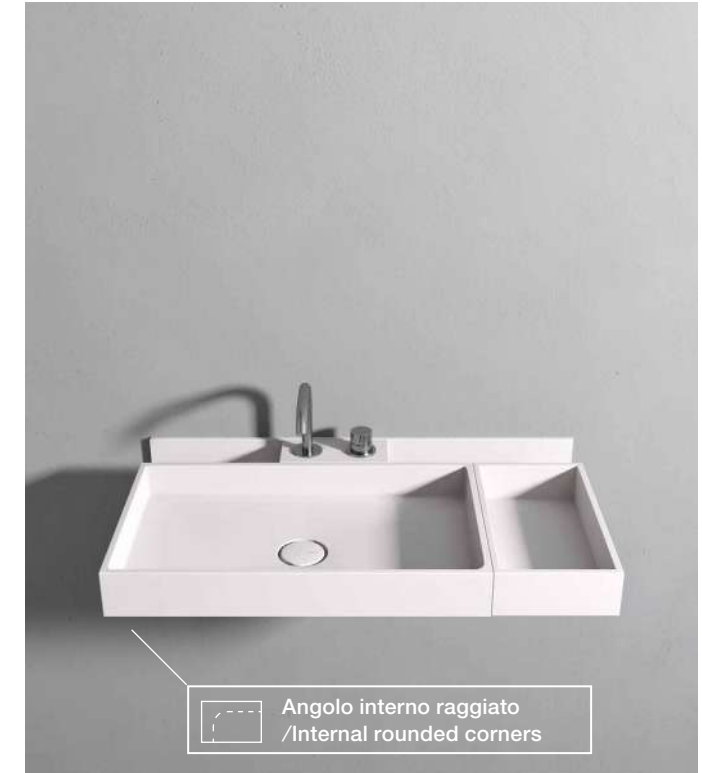
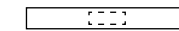

Lavabo con consolle trucco e organizer
/Basin with with make-up console and organizer
Appoggio/Over counter



Sx + Dx
L 100-120 P 46 H 8 cm

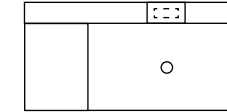

Optional
Portarubinetto
/Mixer support

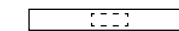



IT Accostamenti cromatici e materici. Basi, lavabi accessoriati, elementi contenitivi, pensili e vaschette per mixare fra loro diversi materiali.

EN Combinations of colours and materials. Units, equipped washbasins, storage elements, wall units and trays, mixing different materials together.

FR Combinaisons de couleurs et matières. Éléments, vasques équipées, éléments de rangement, meubles hauts et bacs permettent de combiner différents matériaux.

DE Ergänzt durch chromatische und materische. Werkstoffe, Nebenschränke, ausgestattete Waschbecken, Aufbewahrungselemente, Oberschränke und Tablett zum Mischen verschiedener Materialien.

ES Combinaciones de colores y materiales. Muebles, lavabos accesorios, elementos de almacenamiento, muebles altos y lavabos para combinar distintos materiales.

Vaschette lamiera/Metal trays

Tipologia/Type

Materiali e colori
/Materials and colours

Vaschette lamiera
/Metal trays
L 20-30 P 46 H 8 cm

Lamiera
/Metal
+2

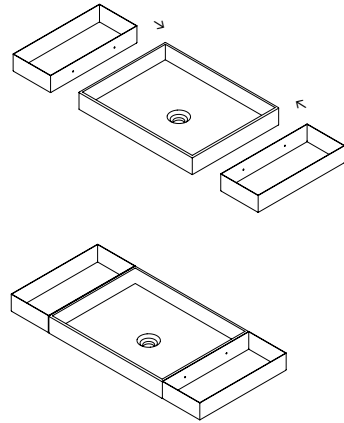

Abbinabile ai lavabi o top H 8 cm
/Suitable with basins or top H 8 cm



Accessori organizer/Organizer accessories



Divisorio/Divider
L 25 P 9 H 6,6 cm



Portaspazzolini/Toothbrush holder
L 5 P 9 H 6,6 cm



Supporto con dispenser
/Dispenser support
L 15 P 9 H 6,6 cm



Supporto con bicchiere/Glass support
L 15 P 9 H 6,6 cm



Supporto con bicchiere e dispenser/Glass
and dispenser support
L 25 P 9 H 6,6 cm



Supporto con doppio bicchiere
/Double glass support
L 25 P 9 H 6,6 cm



Supporto con doppio dispenser/Double
dispenser support
L 25 P 9 H 6,6 cm



Dispenser



Bicchieri/Glass

Accessori/Accessories

Tipologia/Type

Materiali e colori
/Materials and colours

Portasalviette a parete
/Wall hung towel rail
L 46 P 10 H 8 cm

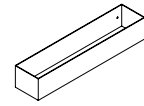

Portasalviette per lavabo
/Towel rail on basin
L 46 P 10 H 8 cm

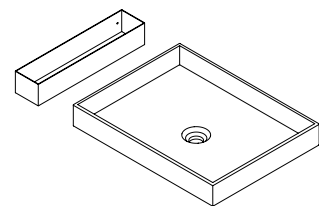

Accessori/Accessories

Tipologia/Type

Materiali e colori
/Materials and colours

Mensola contenitiva
/Wall holder shelf
L 30 P 10 H 8 cm



Mensola contenitiva
/Wall holder shelf
L 60 P 10 H 16 cm

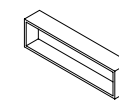

Disponibile integrata a specchiera
/Suitable for mirror

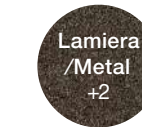
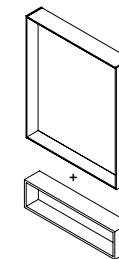

Materials and colours of Rexa

IT Rexa delinea i mondi materici coordinandoli per cromia e tattilità attraverso un sistema intuitivo e logico, pensato per un'efficace progettazione sensoriale dello spazio.

EN Rexa outlines the material worlds coordinating them by colour and tactility through an intuitive and logical system, designed to enhance the sensory spirit of space.

FR Rexa définit les mondes matériels en les coordonnant par chromie et tactilité à travers un système intuitif et logique, conçu pour une efficace conception sensorielle de l'espace.

DE Rexa definiert seine Materialwelten, indem es sie auf der Grundlage von Farben und Taktilität durch ein intuitives und logisches System koordiniert, das für eine wirksame, sensorische Gestaltung des Raums entwickelt wurde.

ES Rexa delinea los materiales coordinándolos por cromia y tacto a través de un sistema intuitivo y lógico, pensado para un eficaz diseño sensorial del espacio.

Laccato/Lacquered

Lucido/Glossy (2#), Opaco/Matt (3#)

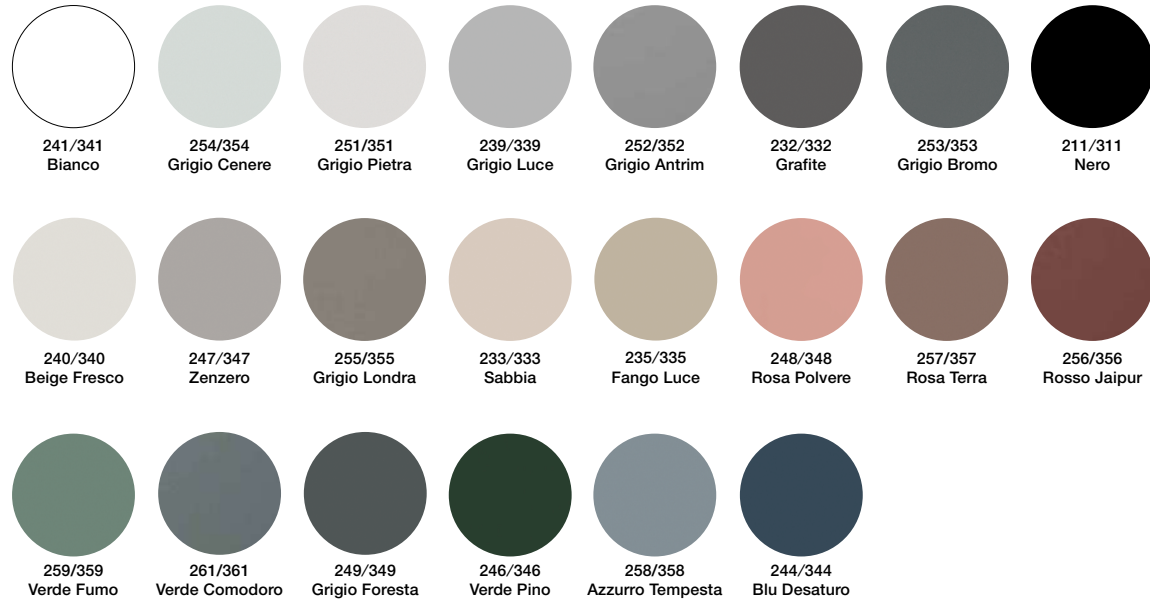

Corian®



Legno/Wood



Argilla/Clay

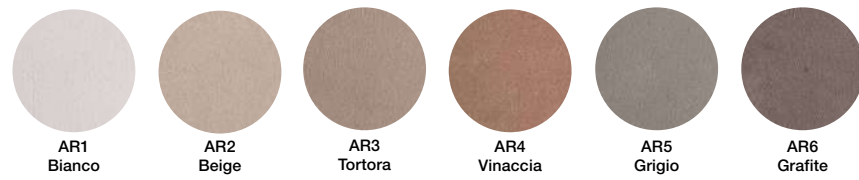

Lamiera/Metal

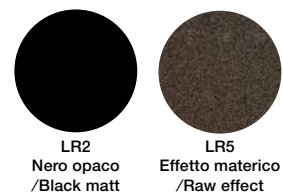



Materials, Colours

About

Monica Graffeo



La collaborazione con Monica Graffeo come direttore creativo e product designer ha da sempre ispirato Rexa a indagare il rapporto fra tecnologia, benessere e creatività.

I suoi concept propongono una visione che pone al centro la persona e i suoi bisogni reali, quotidiani. La ricerca sull'evoluzione degli spazi e degli stili di vita e l'attenzione alla percezione sensoriale si traducono in soluzioni che aprono scenari progettuali per gli ambienti casa e contract.
MG: "Organizzazione e funzionalità sono state il punto di partenza nei ragionamenti attorno al programma Compact Living. Come rispondere agli spazi contenuti in modo pratico, ma allo stesso tempo affascinante: abbiamo lavorato attorno al concetto di scatola e ritmo, per cui tutto il sistema si basa sulla ripetizione di scatole e sul loro abbinamento attraverso materiali diversi."

The collaboration with Monica Graffeo as creative director and product designer has always inspired Rexa to investigate the relationship between technology, wellness and creativity.

Her concepts suggest a vision that focuses on the person and his/her concrete, everyday needs. The research on the evolution of spaces and lifestyles and the attention to sensory perception are translated into solutions that open up design scenarios for home and contract environments.
MG: "Organization and functionality were the starting point of the Compact Living program. A solution to reduced spaces in a practical but - at the same time - fascinating way: we worked around the concept of storage and rhythm, as the whole system is based on the combination through different materials and the storage spaces."

La collaboration avec Monica Graffeo, directrice créative et designer de produits, a toujours inspiré Rexa à enquêter sur le rapport entre technologie, bien-être et créativité.

Ses concepts proposent une vision qui place au centre la personne même et ses besoins réels, quotidiens. La recherche sur l'évolution des espaces et des styles de vie et l'attention à la perception sensorielle se traduisent par des solutions qui ouvrent des scénarios de conception pour les environnements domestiques et contract.
MG: "L'organisation et la fonctionnalité ont été le point de départ du raisonnement autour du programme Compact Living. Une solution aux espaces réduits d'une manière pratique mais - en même temps - fascinante : nous avons travaillé autour du concept de

rangements et de rythme, comme l'ensemble du système est basé sur la combinaison à travers différents matériaux et les espaces de rangement."

Die Zusammenarbeit mit Monica Graffeo als Kreativdirektorin und Produktdesignerin hat Rexa stets dazu inspiriert, die Beziehung zwischen Technologie, Wellness und Kreativität zu untersuchen.

Ihre Konzepte legen eine Vision nahe, die sich auf den Menschen und seine konkreten, alltäglichen Bedürfnisse konzentriert. Die Erforschung der Entwicklung von Räumen und Lebensstilen und die Aufmerksamkeit für die Sinneswahrnehmung werden in Lösungen umgesetzt, die Design-Szenarien für Wohn- und Objektbereiche eröffnen.

MG: "Organisation und Funktionalität waren der Ausgangspunkt für das Programm Compact Living. Eine Lösung für reduzierte Räume in einer praktischen und gleichzeitig faszinierenden Art und Weise: wir arbeiteten mit dem Konzept der Eingrenzung und Abfolge, so dass das gesamte System auf der Wiederholung von Kästen und ihrer Kombination durch verschiedene Materialien basiert."

La colaboración con Monica Graffeo como directora creativa y product designer ha inspirado Rexa, a investigar la relación entre la tecnología, el bienestar y la creatividad.

Sus conceptos proponen una visión que pone en el centro la persona y sus necesidades reales, cotidianas. La investigación sobre la evolución de los espacios y de los estilos de vida y la atención a la percepción sensorial se traducen en soluciones que abren escenarios de diseño para los ambientes hogar y contract.

MG: "La organización y la funcionalidad fueron el punto de partida para el diseño de Compact Living. Cómo responder a los espacios contenidos de forma práctica y fascinante a la vez: trabajamos en torno al concepto de caja y secuencia, por el que toda la colección se basa en la repetición de cajas y su combinación a través de distintos materiales."

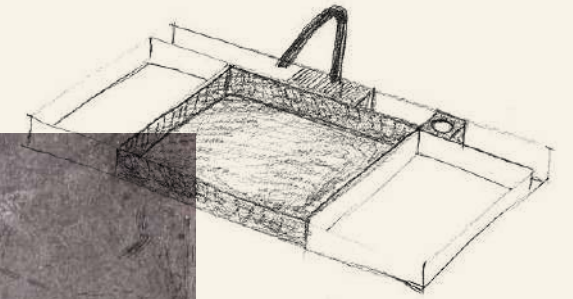
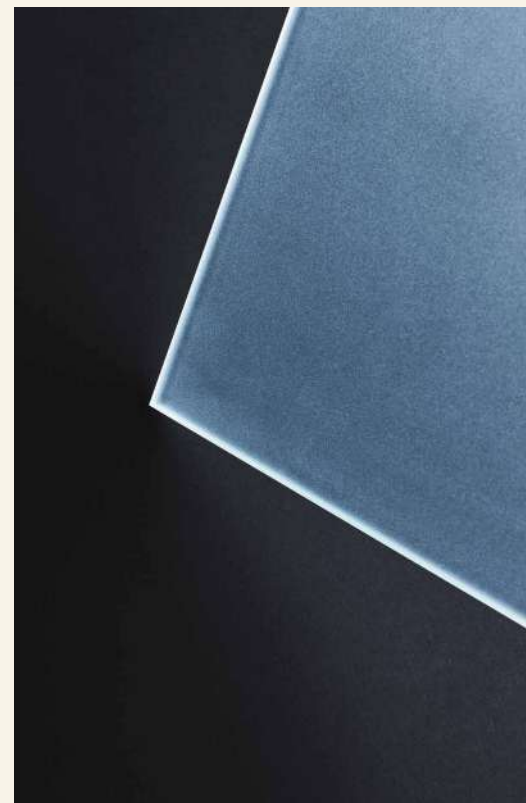
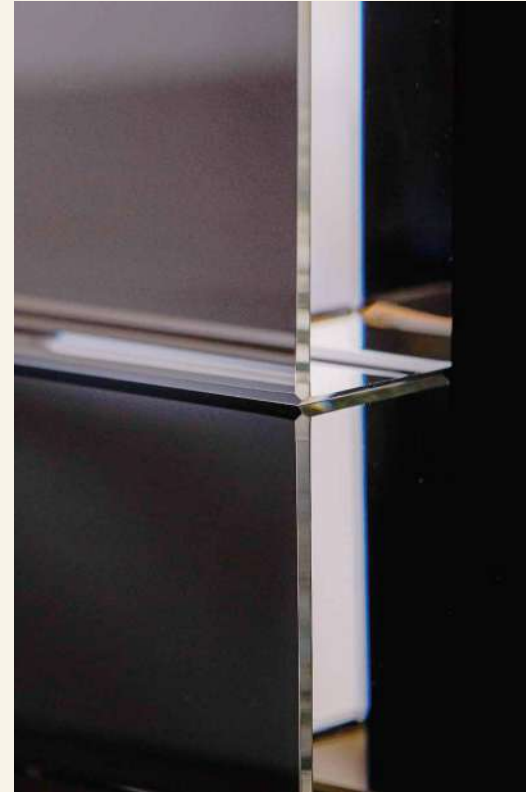

"A solution to reduced spaces in a practical but - at the same time - fascinating way: we worked around the concept of storage and rhythm"



"Come rispondere agli spazi contenuti in modo pratico, ma allo stesso tempo affascinante: abbiamo lavorato attorno al concetto di scatola e ritmo"

Inside Rexa



IT Esploriamo la stanza da bagno attraverso prospettive progettuali inedite, spinti dalla passione per i materiali e dalla curiosità per i modi di vivere questo spazio della casa, intimo e funzionale allo stesso tempo. Il design, la ricerca e la progettazione sono alla base del nostro operare, ci mettiamo in ascolto del mondo esterno interpretandone le suggestioni e dialoghiamo con i progettisti e i nostri clienti, mettendoci al loro fianco nell'impresa di progettare spazi per la vita delle persone.



EN We explore the bathroom through new design perspectives, driven by the passion for materials and curiosity for the ways of living this space of the house, intimate and functional at the same time. The design, the research and the project are the basis of our work, we listen to the outside world by interpreting its suggestions and we speak with the designers and our customers, sharing with them the business of designing spaces for people's lives.



FR Nous explorons la salle de bain à travers de nouvelles perspectives de design, animés par la passion des matériaux et la curiosité pour les façons de vivre cet espace de la maison, intime et fonctionnel à la fois. Le design, la recherche et le projet sont la base

Inside Rexa

de notre travail, nous écoutons le monde extérieur en interprétant ses suggestions et nous parlons avec les designers et nos clients, partageant avec eux le métier de concevoir des espaces pour la vie des gens.

DE Wir erforschen das Badezimmer aus neuen Designperspektiven, angetrieben von der Leidenschaft für Materialien und der Neugierde, wie man diesen intimen und doch funktionalen Raum im Haus erleben kann. Design, Forschung und Planung sind die Grundlage unserer Arbeit, wir hören auf die Welt da draußen, interpretieren ihre Anregungen und stehen im Dialog mit Designern und unseren Kunden, um gemeinsam mit ihnen Räume für das Leben der Menschen zu gestalten.

ES Exploramos el cuarto de baño a través de perspectivas de diseño inéditas, impulsados por la pasión por los materiales y la curiosidad por las formas de vivir este espacio de la casa íntimo y funcional al mismo tiempo. El design, la investigación y el diseño son la base de nuestro trabajo, nos ponemos a la escucha del mundo exterior interpretando las sugerencias y dialogamos con los diseñadores y nuestros clientes, poniéndonos a su lado en la empresa de proyectar espacios para la vida de las personas.





Comp. 1 p 14

Laccato opaco
/Matt lacquered Grafite,
Rovere/Oak Black,
Corian® Carbon Concrete,
Lamiera verniciata nera
/Black lacquered metal



Comp. 2 p 20

Laccato opaco
/Matt lacquered Zenzero,
Rovere/Oak Tobacco,
Korakril™ Blend Ice White,
Lamiera effetto materico
/Metal raw effect



Comp. 3 p 32

Rovere/Oak Tobacco,
Lamiera effetto materico
/Metal raw effect
Corian® Ash Aggregate,
Corian® Neutral Concrete



Comp. 4 p 42

Argilla/Clay Beige,
Lamiera effetto materico
/Metal raw effect



Comp.5 p 48

Laccato opaco
/Matt lacquered Rosa Polvere,
Rovere/Oak Tobacco,
Corian® Dune Prima,
Corian® Neutral Concrete



Comp. 6 p 60

Laccato opaco
/Matt lacquered Beige Fresco,
Korakril™ Blend Ice White



Comp. 7 p 68

Laccato opaco
/Matt lacquered Bianco,
Lamiera nera opaca/Black matt
lacquered metal,
Shark Bianco



Comp. 8 p 80

Rovere/Oak,
Marmo/Marble Nero Marquinia,
Corian® Deep Nocturne



Comp. 9 p 88

Argilla/Clay Grafite,
Korakril™ Stone Sabbia

Composition Index

Contatti

per informazioni e contatto
for further information and contact

Rexa Design Srl
Via Maniago 57/a
33080 San Quirino (PN) - Italy
+39 0434 593182
info@rexadesign.it

Flagship Store Milano
Via Molino delle Armi 14
20123 Milano
milano@rexadesign.it

scopri/discover more
rexadesign.it



Credits

Creative direction
– Monica Graffeo

Brochure
– Concept and design
Chiara Torelli
– Image production
Studio Iride
– Styling
Stefano Gaggero
– Photolithography
Luce group

Printed in Italy by Grafiche Antiga
03 2023

REXA

©2023 Rexa Design Srl
All rights reserved.

progettoincontra2022

CONTRA
Rete d'impresa
incontrasolutions.it

